



Fael Security Srl  
Via E. Majorana  
72100 Brindisi - ITALIA  
Tel. 0831-546563 Fax 0831-546674  
E-mail: fael@fael.com  
Web: http://www.faelsecurity.com

## El2 120 SLIDING DOOR "CROSSWALK 120"

Marked according to EN 16034:2014 and 13241:2016

- Fire rated sliding door for Internal use and covered areas.
- Install in a draught-free environment.
- Installation to be made only by specialised personnel.
- Install on plumb and coplanar compartments or structures.

Client: \_\_\_\_\_

CTR.N°: \_\_\_\_\_ dd \_\_\_\_\_

**S1/P2s.en**

(Sheet Mod. 850-A)

### Front View

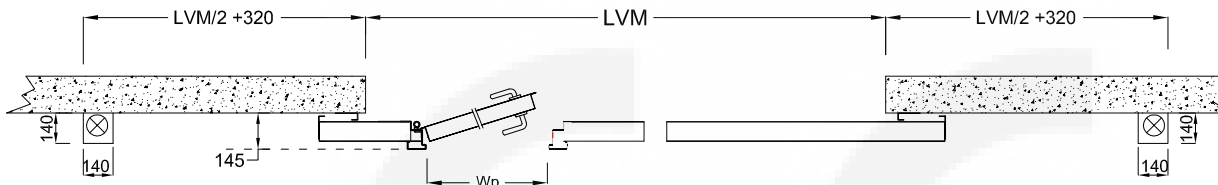
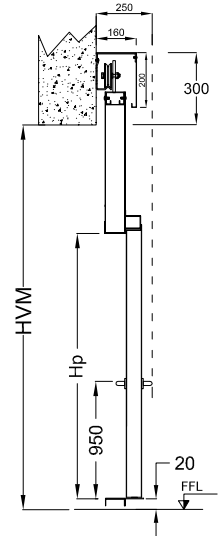
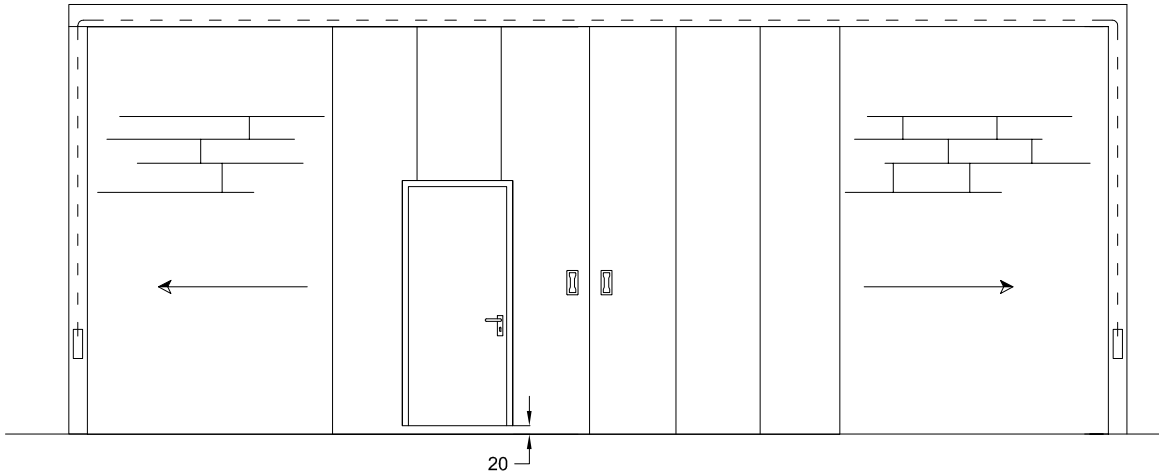

LVM = Structural Opening Width  
HVM = Structural Opening Height  
Wp = Passage Width (door)  
Hp = Passage Height (door)  
FFL = Finished Floor Level

Pedestrian door Push side

Example of sliding door double leaves front view with insertion of pedestrian door push left placed on the left leaf of sliding door

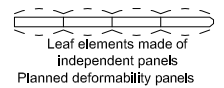

**Pedestrian door push side**

<input type="checkbox"/>	<input type="checkbox"/>	<input type="checkbox"/> Wp.= 950xHp.= 2020
<input type="checkbox"/>	<input type="checkbox"/>	<input type="checkbox"/> Wp.= 1200xHp.= 2020
<input type="checkbox"/>	<input type="checkbox"/>	<input type="checkbox"/> Wp.= 950 xHp.= 2120
<input type="checkbox"/>	<input type="checkbox"/>	<input type="checkbox"/> Wp.= 1200xHp.= 2120

Push Left      Push Right

*Double leaves symmetrical sliding door*  
LVM = \_\_\_\_\_ mm x HVM = \_\_\_\_\_ mm

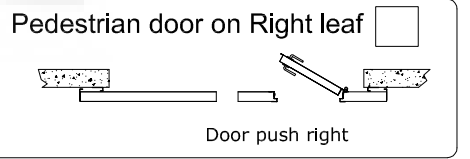
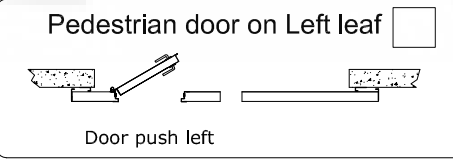
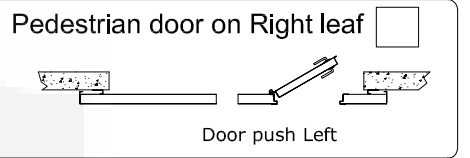
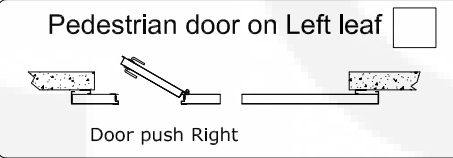

**ACCESSORIES**

*MANDATORY*

Double Electromagnet + push button release

Double Radial Damper

Double Shock absorber

*PEDESTRIAN DOOR*

Couple of handle

Push-bar (black body and red bar)

Vision Panel dim. 300x400 mm

Note: Handle/panic bar height = 950 mm

*OPTIONALS*

Smoke Tightness Sa (EN 1634-3:2005)

Night Lock (External application)

Detector (smoke and heat) RFC

Single zone fire Alarm RFC/C

RAL: \_\_\_\_\_

Note:

Note: Anchoring screws for the structure are **NOT** included.

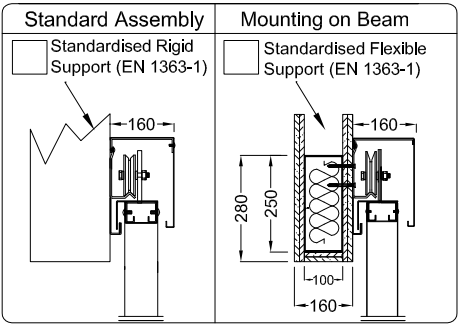
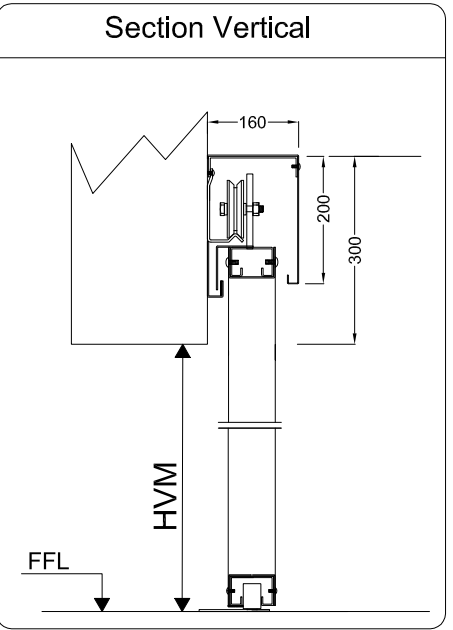

Date -- Stamp and Signature